

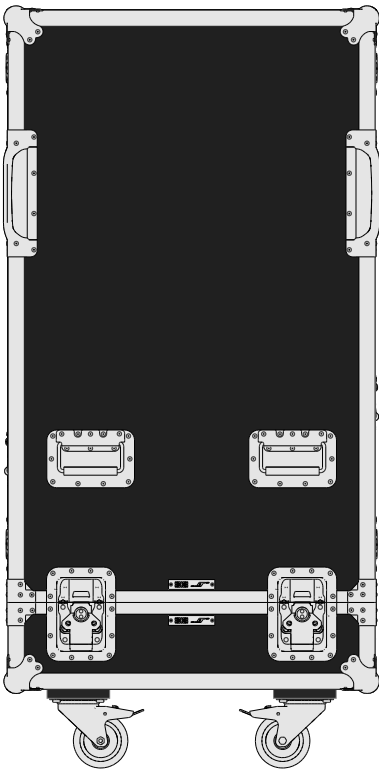

Part No
96557-1

Drawn By
Nick L

Front



Back

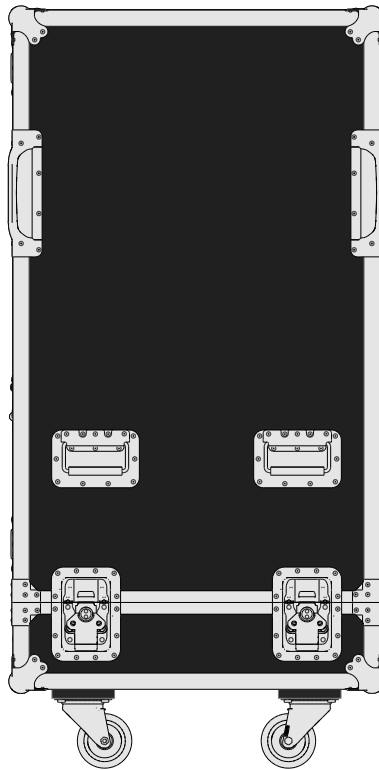

Right

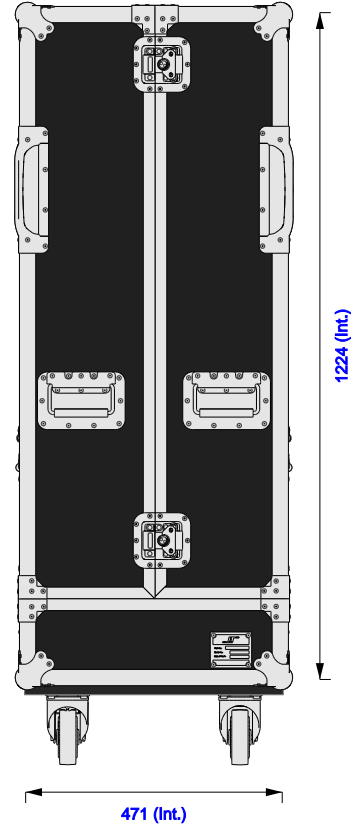

Left

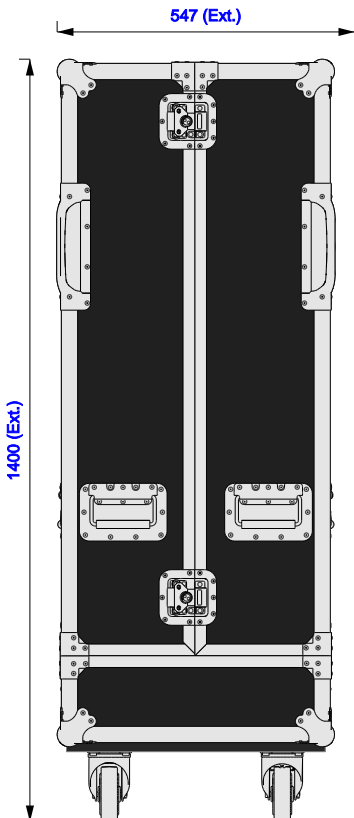

Plan

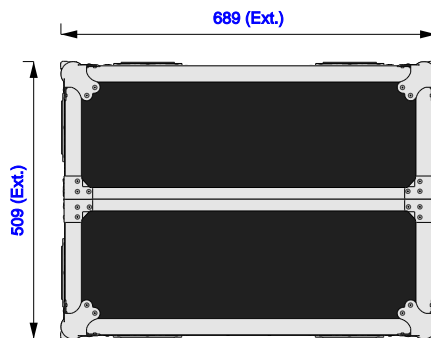

Underside

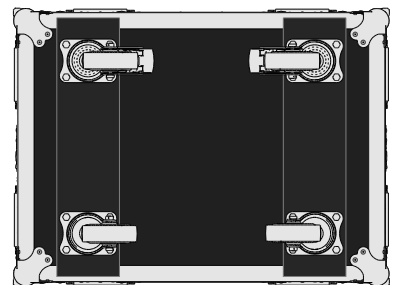



Part No
96557-1

Drawn By
Nick L

Plan - Base only

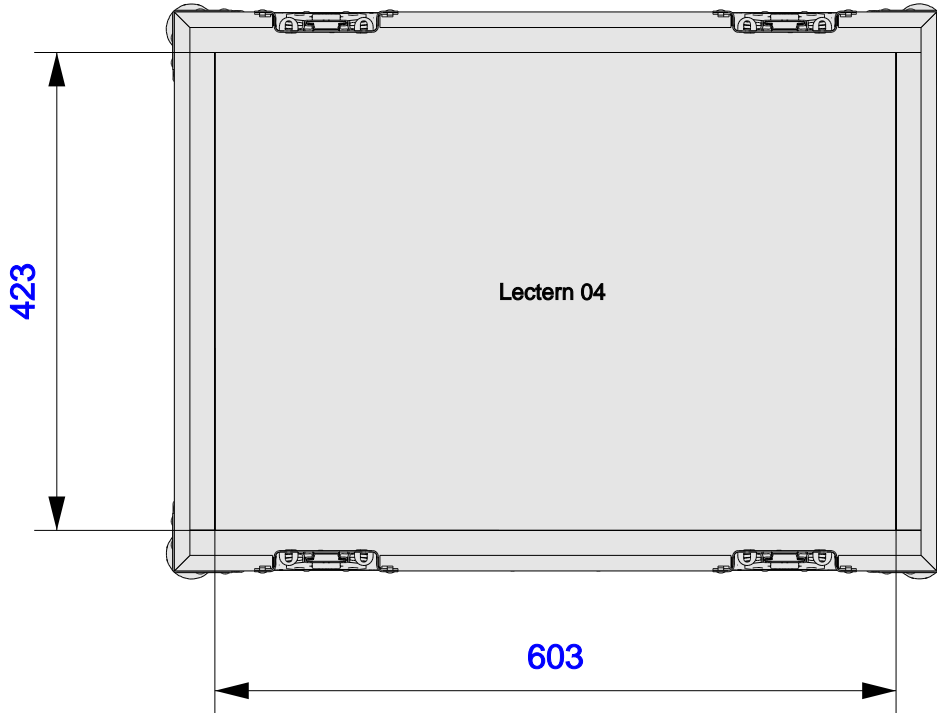

Lectern 04
Length: 600mm
Width: 420mm
Height: 1180mm

Underside - Lid (front), Lid (back) only

