

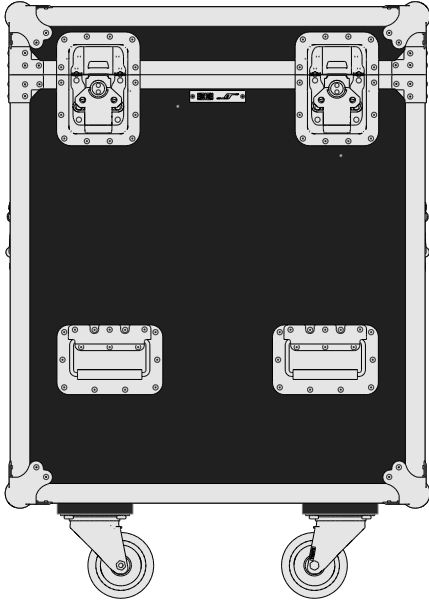

Part No
96263-1

Drawn By
Nick L

Front



Back

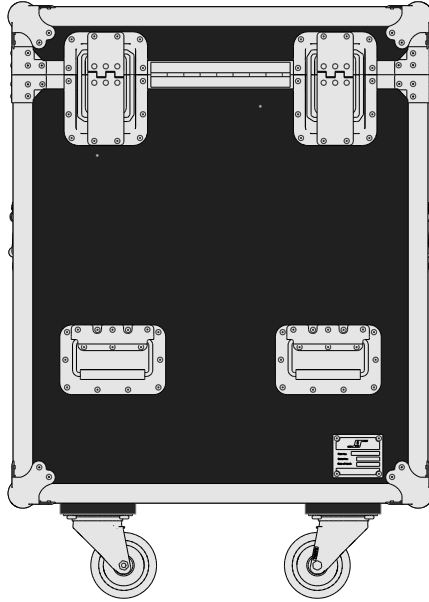

Right

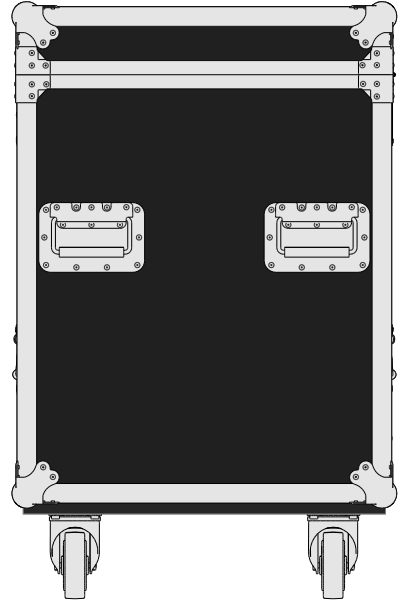

Left

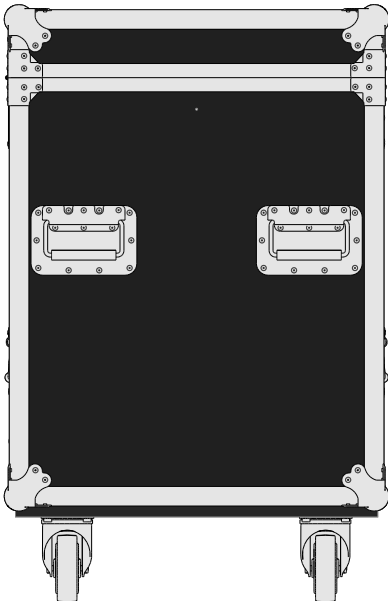

Plan

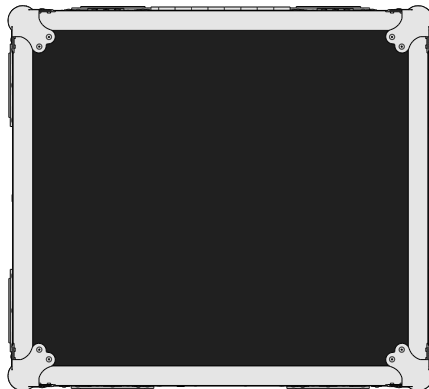

Underside

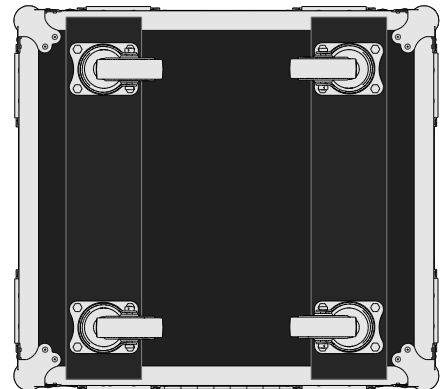



Part No
96263-1

Drawn By
Nick L

Plan - Base only

Allowing for 135mm clamp attached.

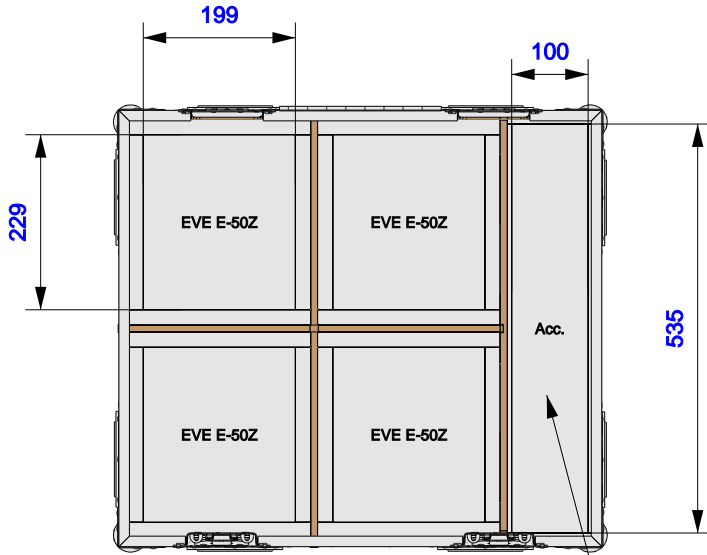

False base fitted
Cavity height - 350mm

EVE E-50Z Extra Height
Length: 195mm Hook clamp
Width: 225mm 135mm
Height: 565mm

Underside - Lid only

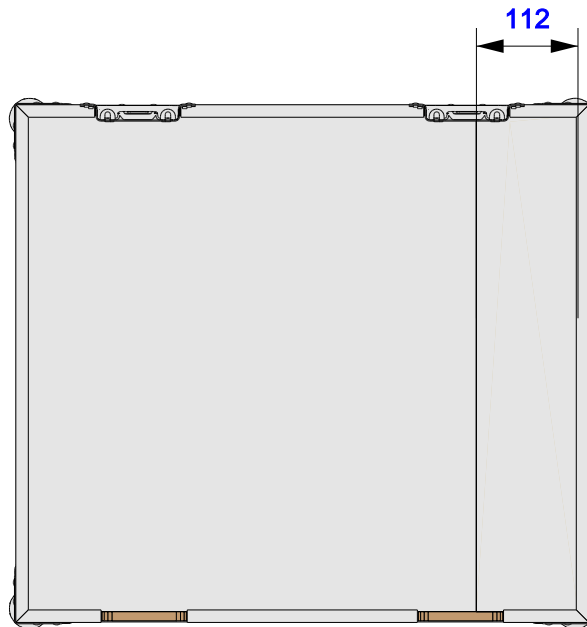

± 3mm tolerance apply to cavity dimensions.
Unless stated otherwise.