



Part No
88093-1

Drawn By
Nick L

Front



Back

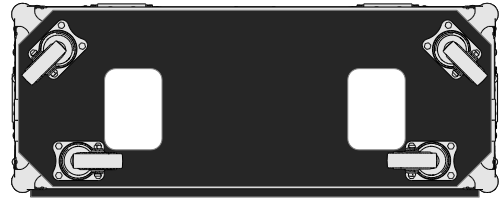

Left

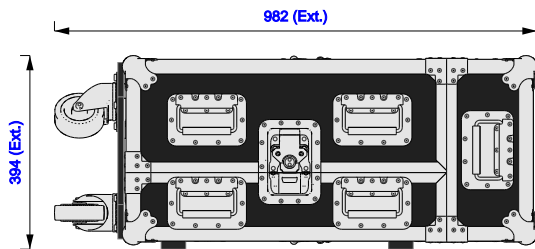

Plan

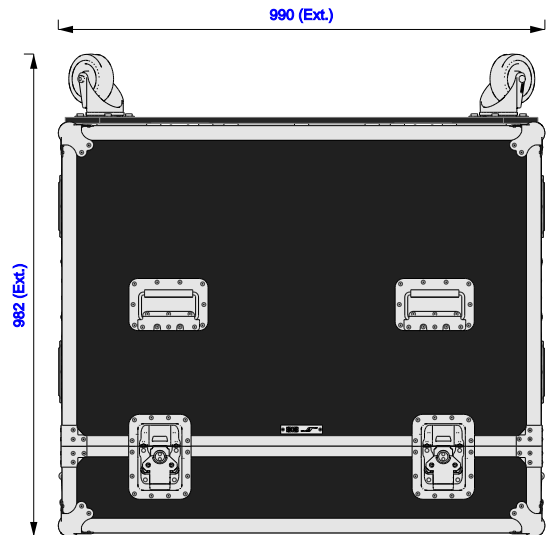

Underside

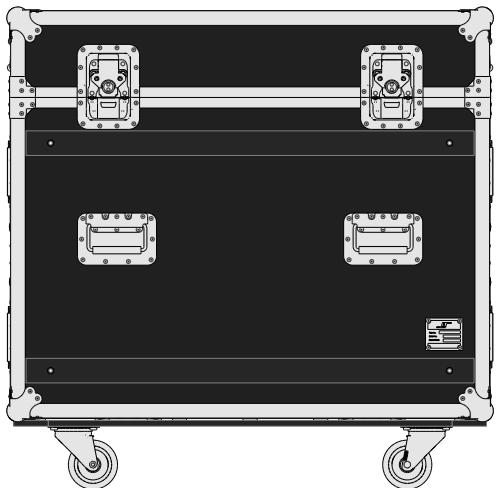

Right

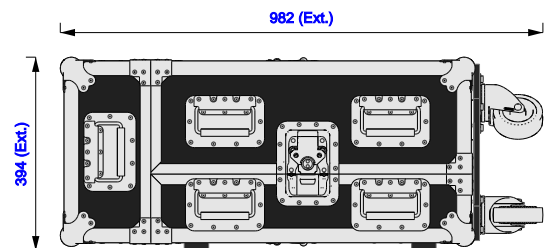



Part No
88093-1

Drawn By
Nick L

Plan - Base only (filtered)

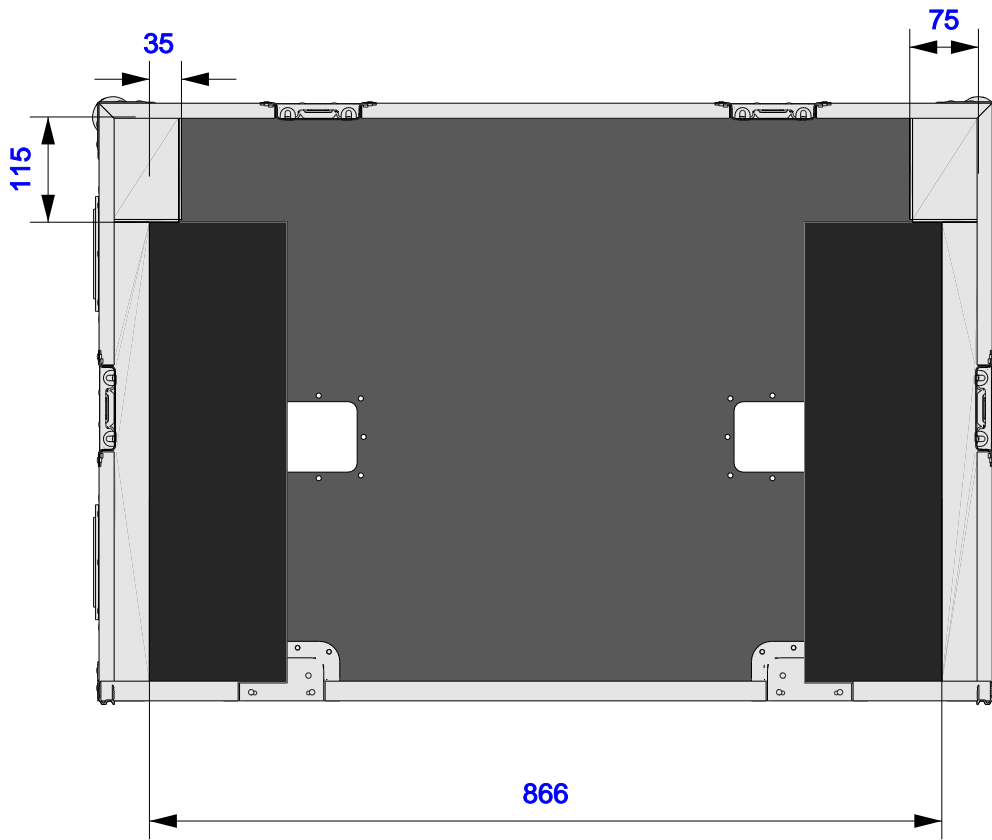

Underside - Lid only

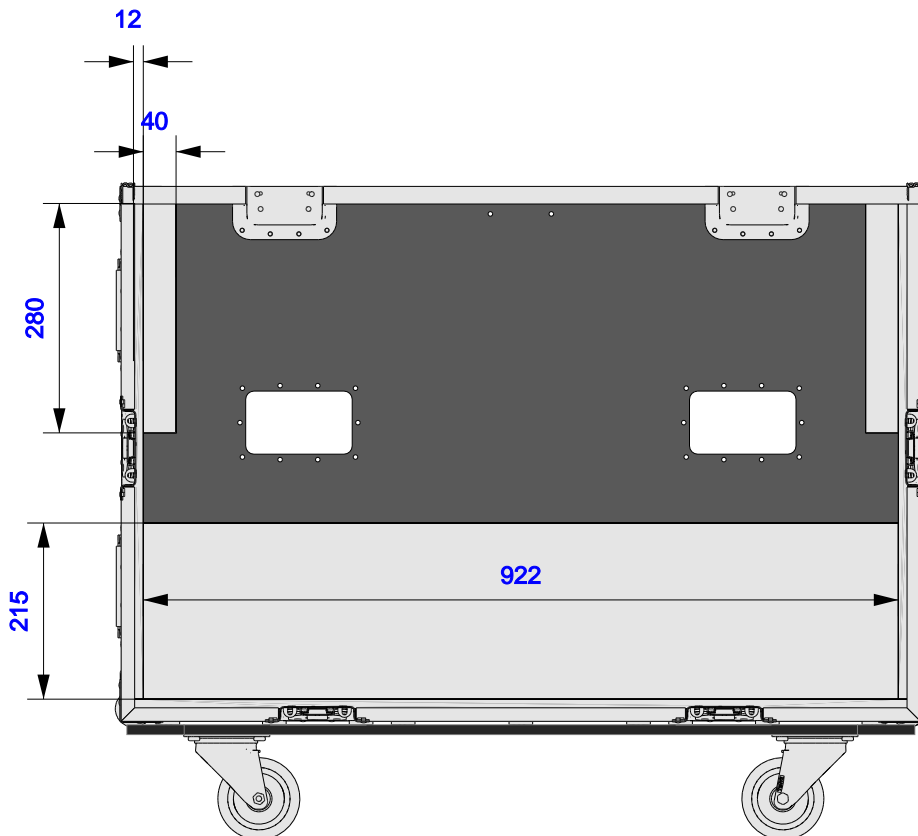



Part No
88093-1

Drawn By
Nick L

showing kit in position

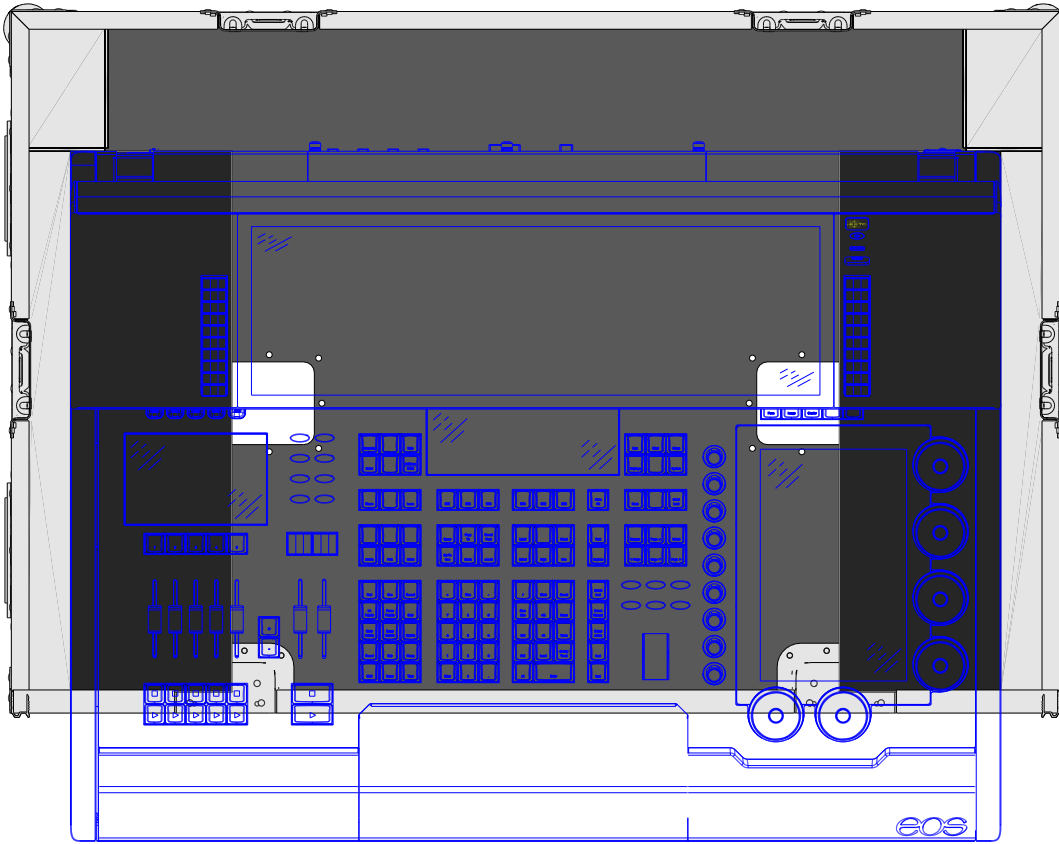

Back - Nosecone only

